

General Arrangement

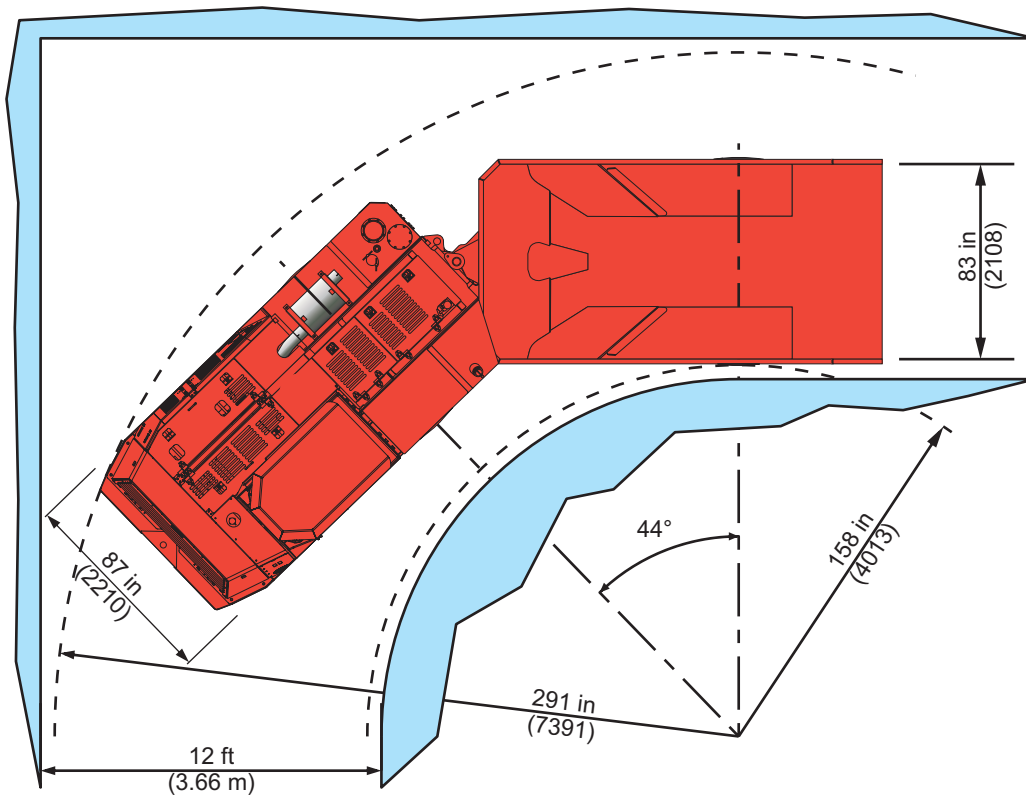
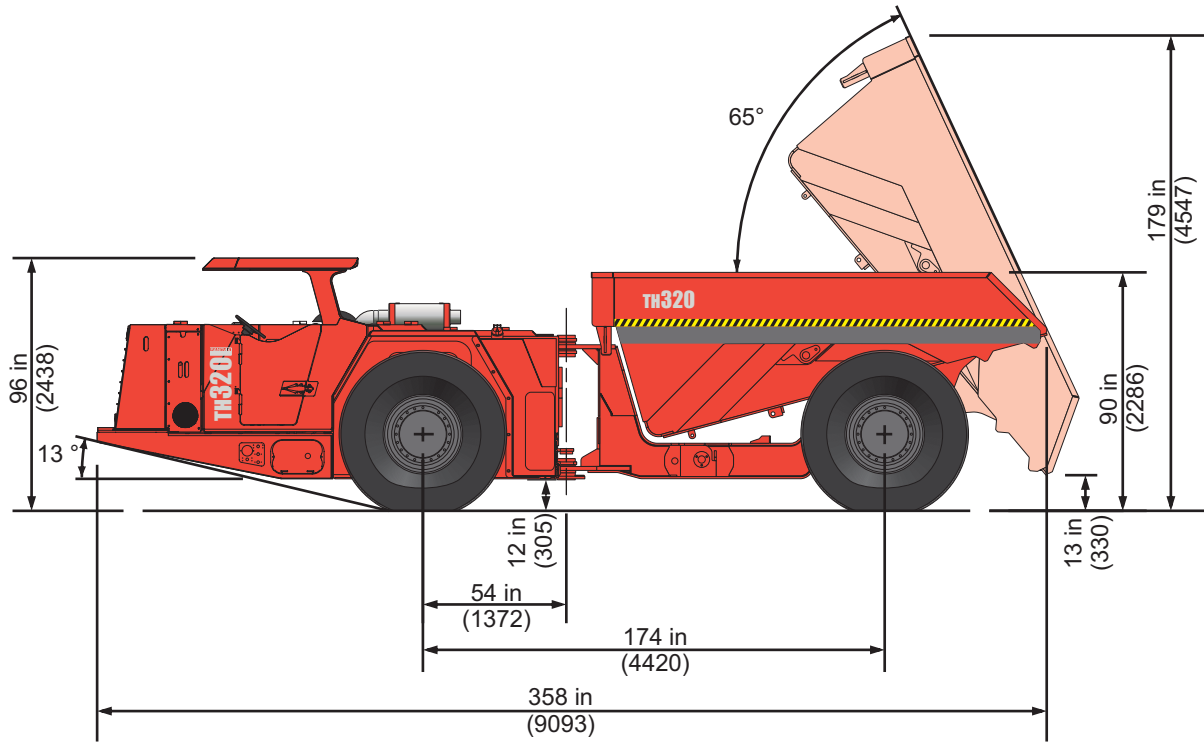

Standard Unit Specifications

General Information

Main Dimensions

Total length	9093 mm	358 in
Total width	2210 mm	87 in
Height with safety canopy	2438 mm	96 in
Height of dump box	2286 mm	90 in
Dump Height	4547 mm	179 in

Operating Weights

Total	22317 kg	49200 lb.
Front axle	16465 kg	36300 lb.
Rear axle	5851 kg	12900 lb.
Shipping weight	22045 kg	48600 lb.

Loaded Weights

Total	42275 kg	93200 lb.
front axle	20412 kg	45000 lb.
rear axle	21863 kg	48200 lb.

Capacities

Payload	20 tonnes	22 tons
Dump box volume (SAE)	10.2 m ³	13.4 yd ³

Dump Box Motion Times

Discharging time	14 sec.
Dumping angle	65 °

Driving Speeds Forward and Reverse (Loaded)

1st gear	6.6 km/h	4.1 m.p.h.
2nd gear	12.0 km/h	7.5 m.p.h.
3rd gear	21.1 km/h	13.1 m.p.h.
4th gear	38.0 km/h	23.6 m.p.h.

Frame

Rear and front frame	Welded steel box construction
Material	G40.21 - 50wt Cat. #3
Central hinge	Full plate, clevis type with spherical bearings
Dump box construction	Welded steel box construction
Material	G40.21 - 50wt Cat. #3

Power Train

Engine

Diesel engine	Mercedes OM 926 LA, Tier 3	
Output	240 kW (322 HP) @ 2200 RPM	
Torque	1300 Nm (959 lb.ft.) @1300 - 1600 RPM	
Number of cylinders	In line 6	
Displacement	7.2 litres (439 in ³)	
Cooling system	Liquid Cooled	
Combustion principle	Direct injected, turbo charged, after cooled	
Air filtration	Donaldson, dry type	
Electric system	24 V	
Exhaust system	Catalytic purifier with silencer	
Fuel consumption (60% duty factor)	35.8 l/h	9.47US gal./h
Fuel Capacity	341 l	90 US gal.

Converter

Dana SOH C8000 series	Single stage, 2.292 torque multiplication ratio, 0.895 offset ratio with manual lock-up
-----------------------	-----------------------------------------------------------------------------------------

Transmission

Dana SOH 6000 series	4-speed forward and reverse
----------------------	-----------------------------

Axles

Front axle	Dana SOH 19D2748, standard differential, oscillating $\pm 7^\circ$.
Rear axle	Dana SOH 19D2748, standard differential, fixed.

Tires

Tire size	18.00R25 **		
Air pressure, front	689 kPa	6.89 bar	100 psi
Air pressure, rear	689 kPa	6.89 bar	100 psi

Systems

Steering Hydraulics

Full hydraulic power steering, centre articulated with double acting steering cylinders. Open centre system with a gear pump and wheel steer control.

Turning Radius

Inner	4013 mm	158 in
Outer	7391 mm	291 in
Turning angle	44 °	

Main Components

Hydraulic pump	Gear	
Control valve	Pilot operated	
Steering cylinders	114.3 mm bore X 63.5 mm rod (4½" X 2½")	

Pressure Settings

Main relief	18.6 MPa	186 bar	2700 psi
Port relief valves	16.5 MPa	165 bar	2400 psi

Dump Box Hydraulics

Full hydraulic open-centre system with one gear pump. Oil flows to the dump box hydraulic system from the pump when the steering system is not in use. Push button dump box control.

Main Components

Dump cylinders	Telescopic, 159 mm bore X 133 mm first sleeve X 108 mm second sleeve (6¼" X 5¼" X 4¼")	
Hydraulic pump	Gear pump	
Control valve	Pilot operated	

Pressure Settings

Main relief	15 MPa	151 bar	2200 psi
Port reliefs	16.5 MPa	165 bar	2400 psi
Hyd. oil tank capacity	378 l	100 US gal.	

Standard Brakes

Service brakes are spring applied/hydraulically released, liquid cooled (LCB) multi-disc brakes on all wheels. Service brakes also function as an emergency brake, when the emergency brake system is engaged.

Main Components

Pressure accumulators	Piston type with charging valve
Brake pedal valve	Modulated

Electrical Equipment

Alternator	24V, 175 Amp min
Batteries	2 x 12 V, 950 CCA
Starter	24 V, Heavy Duty
Driving lights	4pcs front, 2pcs rear

Other Standard Equipment

- SAE ROPS/FOPS Canopy
- Electric shift
- Central hydraulic pressure test points
- Central manual lubrication system
- SAE ORS hose fittings

Standard Manuals

All manuals are delivered on CD-ROM in web based format with Adobe PDF output for printing extra copies and one paper copy. Extra copies are also available as an option.

Manual Type	CD-ROM	Paper
Spare parts manuals	2 Copies	1 Copy
Operator's manual	2 Copies	1 Copy
Service manual	2 Copies	1 Copy

Optional Equipment Specifications

Available Alternative Equipment

Enclosed Cabin	ROPS/FOPS, forward facing operator's compartment with air conditioning and wheel type steering control.
Auto lube system	Lincoln modular

Available Add-On Options

Heating system	for enclosed cabin option, includes A/C	
Fire suppression systems	Manual - Ansul 6 nozzles, 1 tank	
	Automatic (Checkfire II) - Ansul 6 nozzles, 1 tank	
Hand held fire extinguishers	4.5 kg	10 lb.
	9.1 kg	20 lb.
Exhaust system	Exhaust brake	
Emergency steering system	EC regulations	
Dump box	Ejector Box with hydraulically operated tail gate	
Extra CD-ROM manuals		
Extra paper manuals		

Tractive Effort Curve (Metric Units)

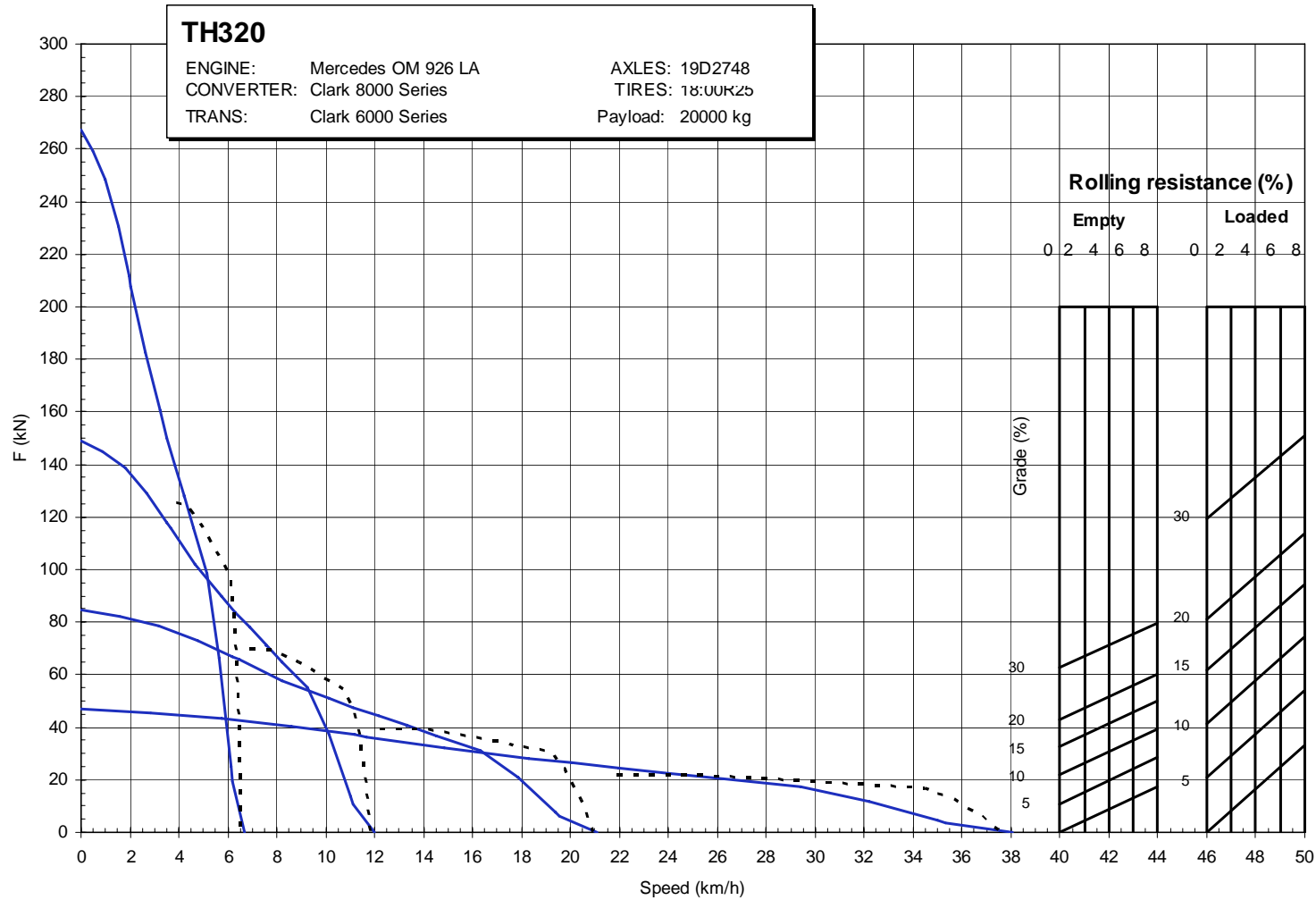

Tractive Effort Curve (US Units)

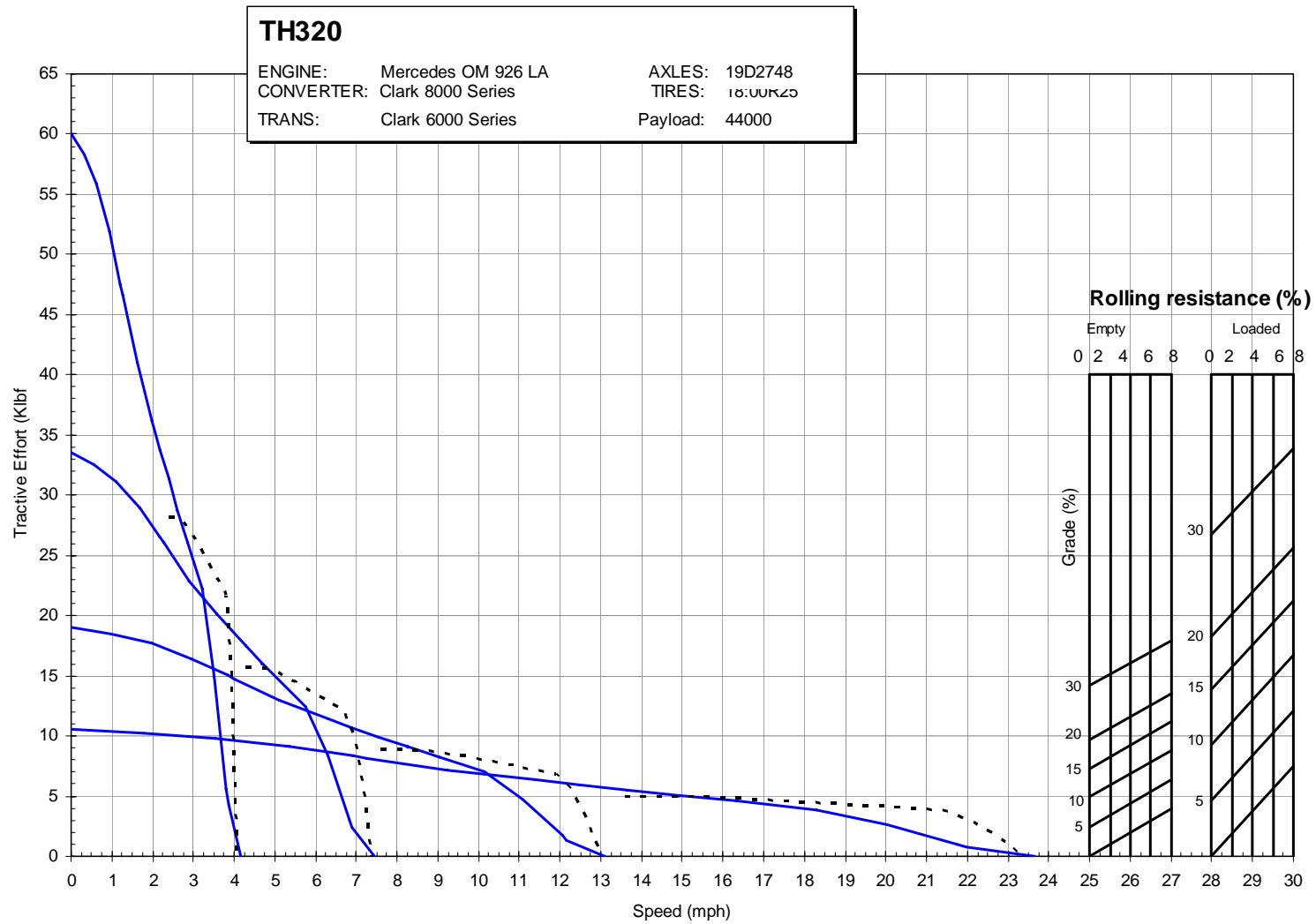

Productivity Curve (Metric Units)

TH320 PRODUCTIVITY

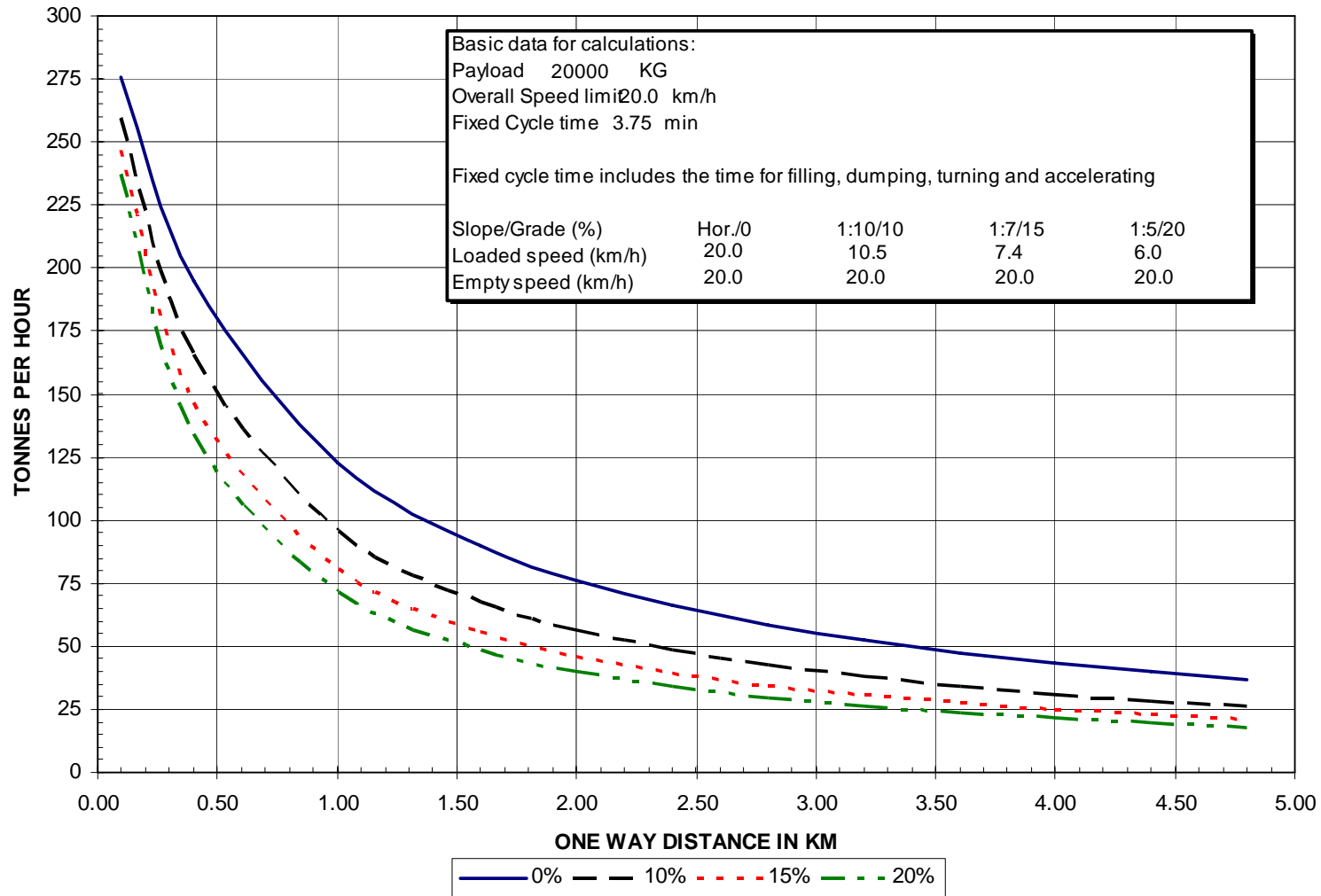

Productivity Curve (US Units)

TH320 PRODUCTIVITY

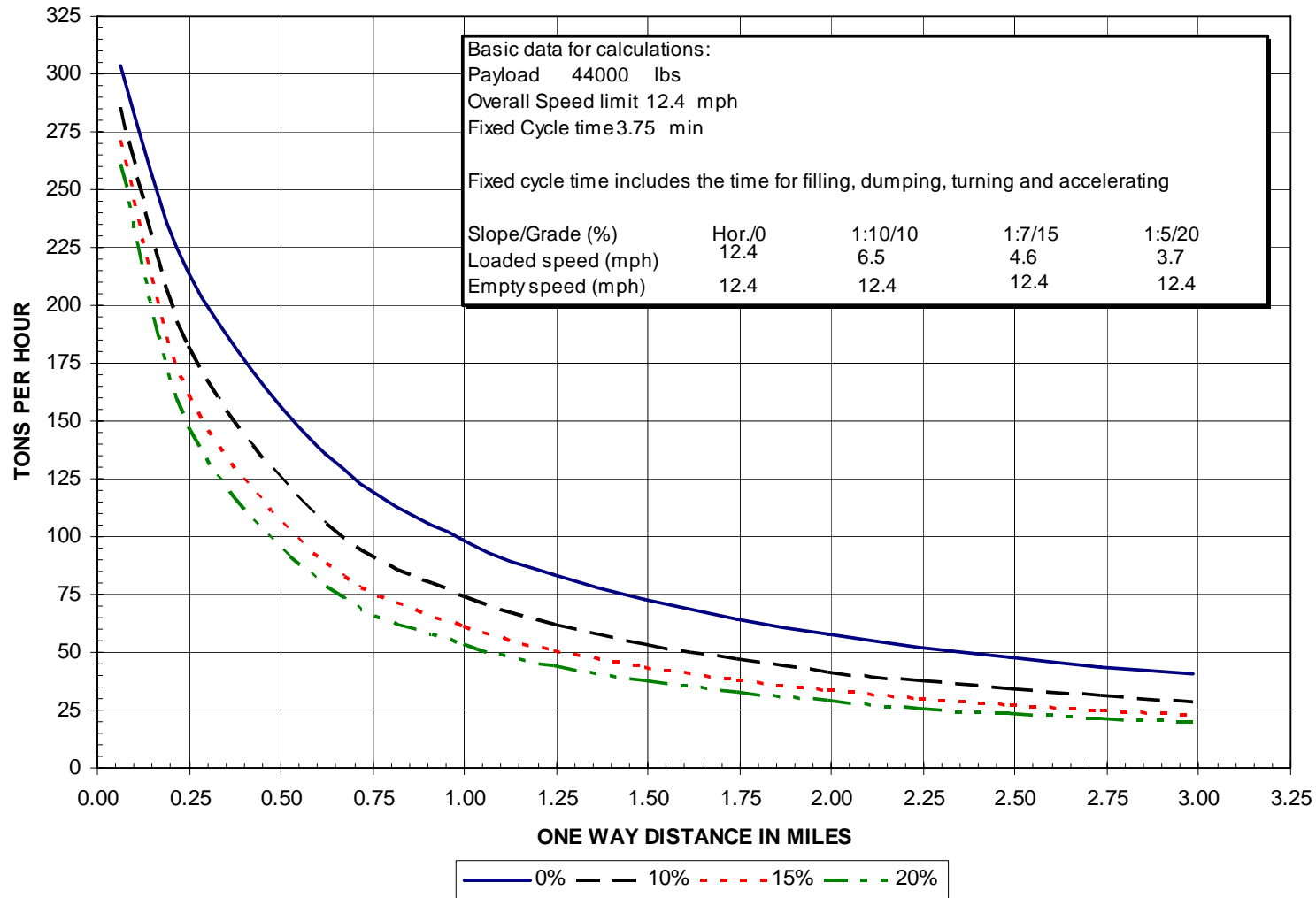

Weights and Dimensions

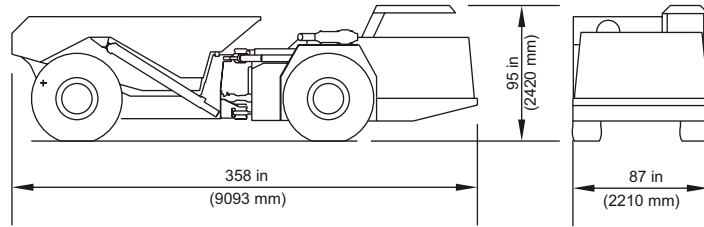

1. Operating condition (empty)
Weight: 50700 lbs (23000 kg)

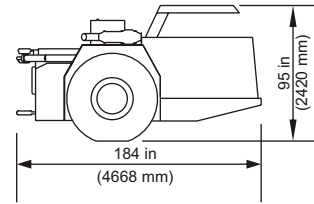

Front part as whole entity
Weight: 31970 lbs (14500 kg)

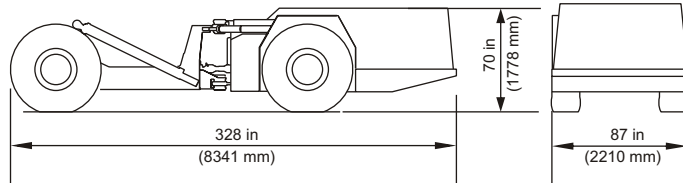

2. Dump box, cab and exhaust removed
Weight: 39250 lbs (17800 kg)

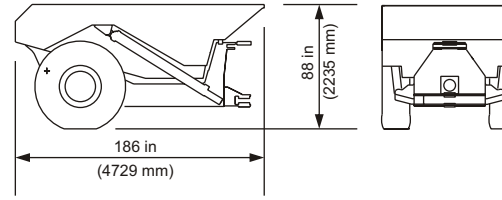

Rear part as a whole entity
Weight: 18740 lbs (8500 kg)

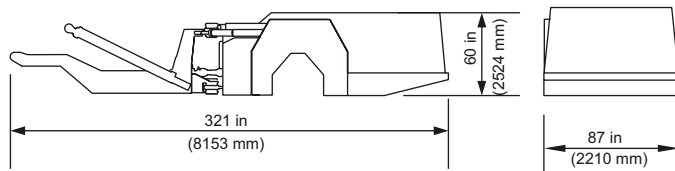

3. Dump box, cab, exhaust, axles and cradle removed
Weight: 27030 lbs (12260 kg)

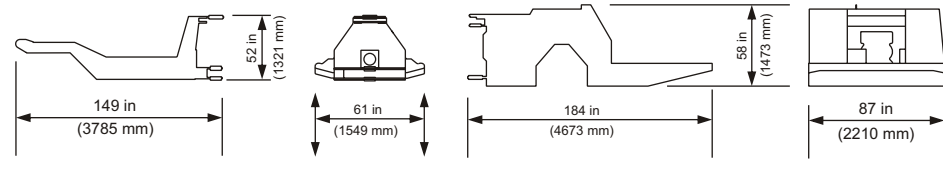

Rear frame bare
Weight: 49809 lbs (2260 kg)

Front frame bare
Weight: 7300 lbs (3310 kg)

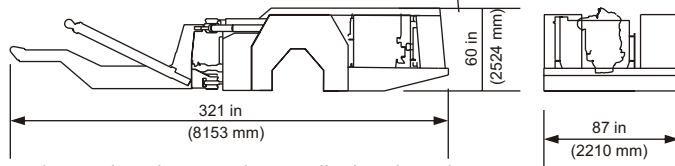

4. Dump box, cab, exhaust, axles, cradle, hoods and covers
Weight: 26340 lbs (11950 kg)

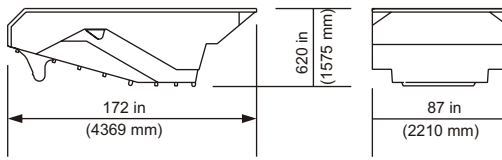

Dump box 13.4yd³ (10.25 m³)
Weight: 7360 lbs (3340 kg)

General Arrangement - 12.6 yd³ (9.6 m³) Ejector Box

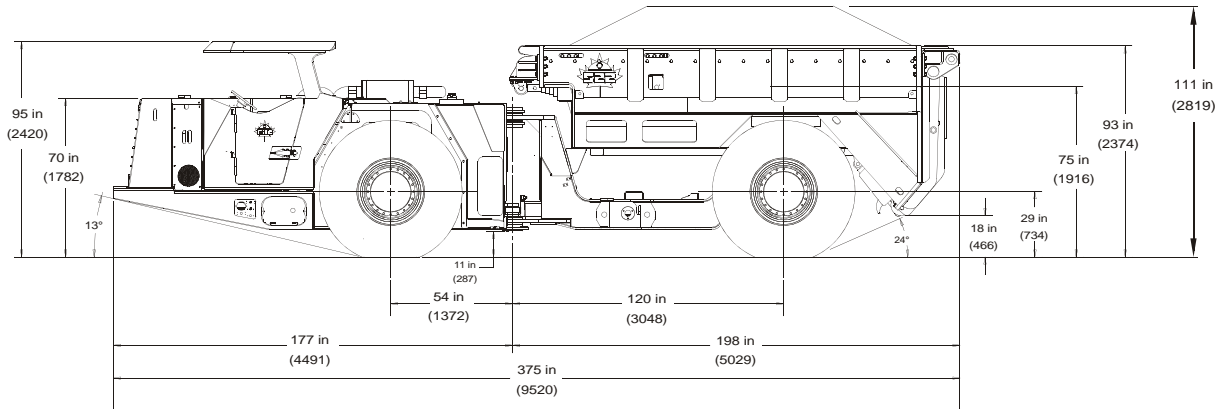

	EMPTY VEHICLE	LOADED VEHICLE
FRONT WHEELS REACTION (LBS)	37300 (63%)	38800 (42%)
REAR WHEELS REACTION (LBS)	21500 (37%)	54000 (58%)
TOTAL WEIGHT OF MACHINE (LBS)	58800	92800

NOTE: FOR MACHINE WITH ENCLOSED CAB, ADD 550 LBS

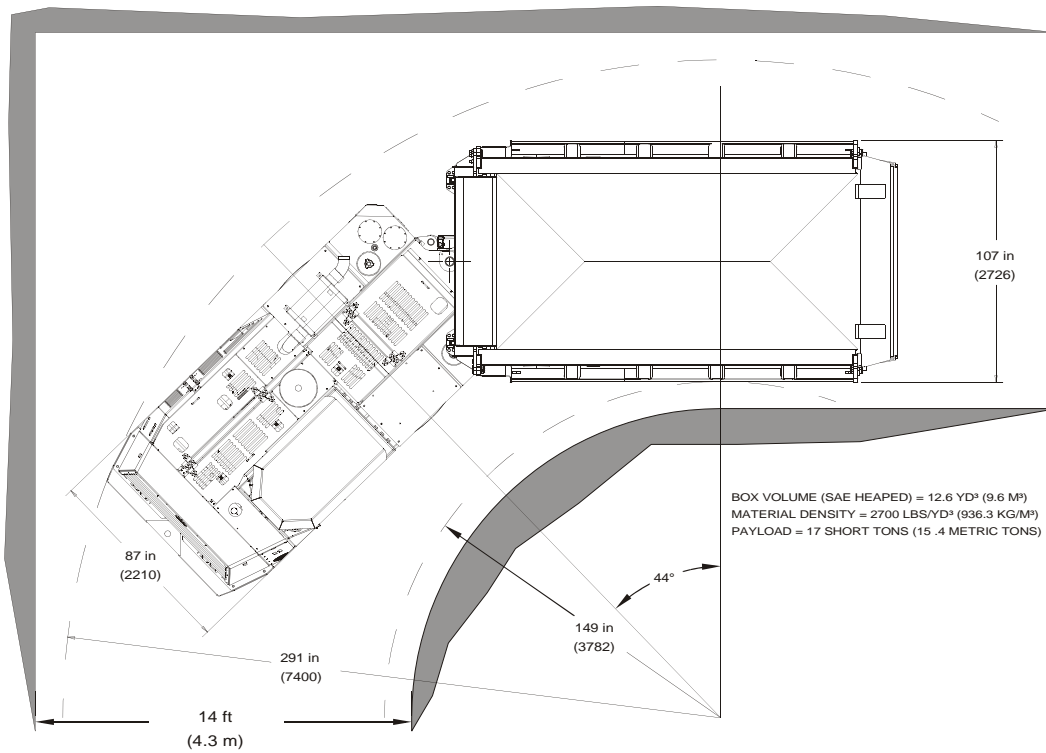



We make it possible